

Modified Article	Date of Application	Date of Publication
Table I-1 NOTE 3	01/01/2019	01/01/2019
Table I-2 Rallies; Club; NOTE 2	01/01/2019	01/01/2019

1. SAFETY HARNESS GENERAL REQUIREMENTS

- (a) A safety harness (including a seat belt) shall be compliant with a Standard as specified below and be fitted and worn in accordance with the manufacturer's directions, with Tables I-1 and I-2 of this Schedule and any additional requirement imposed by specific category, group and/or supplementary regulations.
- (b) Each safety harness shall comply at least with one of the Standards as specified in Table I-1 below.
- (c) Harnesses of a higher level than specified are permitted and encouraged.
- (d) Each safety harness with the words "For FHR use only" which appears on each shoulder strap shall be worn only in conjunction with a FHR device.

Important note:

- (i) Some safety harnesses may not comply with the law. Where the automobile is to be driven on a public road, it is the competitor's responsibility to ensure that it complies with the law.
- (ii) A safety harness damaged in any way, including in a collision, shall be subject to inspection by a scrutineer. If appropriate, the automobile's log book shall be endorsed with a requirement that the belt/harness be replaced.
- (e) The fitment of an elastic cord and or any retention device not homologated by the FIA, which is bonded or sewn to a Safety Harness shoulder strap is not permitted.
 - (i) It is permitted to use a Velcro® piece or alternative to retain the shoulder strap away from the driver during a driver change, provided this does not apply a load or crush to the shoulder strap and its webbing when fitted to restrain the driver.
 - (ii) It is permitted to attach an elastic cord to the waist strap only. Attachment shall be to the metal buckle only.

2. SAFETY HARNESS MOUNTINGS

- (a) A safety harness shall be securely mounted on at least two points (Type D), three points (Types B and C) or five points (Type A) in compliance with the prescriptions of Drawings I-1, I-2 and I-3. If the two shoulder straps (Types B and C) join prior to a common mounting point then that junction shall be at least 150mm behind the wearer's neck. Under no circumstances shall a safety harness mounting bolt be used to affix a safety cage to the bodyshell.
- (b) A safety harness shall be installed in accordance with the manufacturer's instructions with consideration to the requirements when using a Frontal Head Restraint and application of the following:
 - (i) The shoulder straps shall be directed to the rear and installed in such a way that they do not make an angle greater than 45° to the horizontal from the occupant's shoulder where a frontal head restraint is not used. It is highly recommended that this angle should not exceed 10° (refer drawing I-1).
 - (ii) The maximum angles in relation to the centre-line of the seat are 20° divergent or convergent (refer drawing I-2). The shoulder straps may be installed crosswise symmetrically about the centre-line of the front seat mounting points for a safety harness.
- (c) A safety harness shall be mounted using the following:
 - (i) on a series production automobile, any unmodified seat belt mounting point may be used;
 - (ii) where a safety harness is affixed to an un-reinforced section of the body shell, each attachment point shall be reinforced by the use of a plate not less than 75mm x 50mm x 3mm thick (refer drawing I-4);

- (iii) except for a crutch strap mounted in accordance with (e) any bolt used shall be a minimum of 10mm grade 8.8, or an eye bolt to the recognised thread diameter of 7/16" or 11mm except for homologated 1st category applications;
- (iv) shoulder straps may be fixed to the safety cage or to a reinforcement bar by means of a loop, and/or be fixed to a transverse reinforcement compliant with Schedule J of the Manual
 - (A) When looped around a transverse bar adjustment mounting buckles are to be placed as close as possible to the bar to reduce the amount of slip of the shoulder strap mountings.
 - (B) It is permitted to retain a shoulder strap/s into position to maintain FHR adjustment using material such as safety cage padding.
- (d) only a crutch strap or straps may be mounted in accordance with drawing I-6 where the following shall apply:
 - (i) bars shall not bend under a strap load of at least 14.7kN
 - (ii) all edges shall be appropriately rounded (>1.5mm radius)
 - (iii) the bars shall directly clamp on each other firmly clamping the webbing
 - (iv) each attachment point shall be reinforced by the use of a plate in accordance with drawing I-4 or a single plate in accordance with drawing I-5
 - (v) the belt is correctly routed in accordance with drawing I-6

3. FITTMENT OF SAFETY HARNESSES FOR FRONTAL HEAD RESTRAINT (FHR)











- (a) Each safety harness must be compliant with FIA or SFI standards and it is strongly recommended to use only a 6 point harness homologated to FIA standard 8853/98 or FIA standard 8853-2016. A safety harness with either a 75mm or a 50mm wide shoulder strap may be used with FHR. The following shall apply:
 - (i) The length adjustment device of the shoulder strap shall be positioned on the FHR yoke with the upper edge not more than 70mm from the lower edge of the FHR yoke as shown in Drawing I-7.
 - (ii) The shoulder strap anchorage points on the automobile shall be symmetrical about the centre line of the driver's seat. When viewed from above, the angle between the shoulder straps shall be approximately 20°-25° as shown in Drawing I-8.
 - (iii) This can be achieved with reference to the values in Table I-3 which have been calculated based on 75mm wide belts (values for 50mm wide belts are shown in brackets) and four FHR collar sizes according to Drawing I-10. Negative values indicate that the shoulder straps are crossed. These values should be closely respected, but a tolerance of +/-20 mm would be acceptable. Strap movement in the anchorages should be taken into account.
 - (iv) The values in red (underlined> denote that theoretical separation is less than strap width. In this case it is recommended that the straps are installed side by side to avoid any overlap; hence the actual separation shall be equal to the strap width. If the value is negative, the strap should be crossed. Shoulder straps over 200mm long are not recommended.

4. WINDOW NETS

- (a) In a circuit race, each closed automobile which is required to have a safety cage fitted shall have a safety window net fitted in the driver's door window opening.
 - (i) The window net must cover the opening forward to the centre of the steering wheel and be able to withstand a load of 500N applied at any point.
 - (ii) The net may be locally modified to preserve the driver's view of the external mirror.
 - (iii) The net must be affixed by means of a rapid release system so that, even with the automobile inverted it must be possible to detach the mechanism with one hand.
 - (iv) The handle or lever must have coloured markings.
 - (v) A push button release system is authorised provided that it respects the prescriptions of this article. The push button must be visible from the outside, be of a contrasting colour and be marked "press".

- (b) On each automobile derived from series production automobiles manufactured after 1970 and which retains the unmodified door, hinges and latches of the registrable automobile, the net may be mounted to the door frame.
- (i) A method of permanent attachment (metal strip with bolts or rivets) must be used to affix the net to the door and shall incorporate a quick release system.
 - (ii) Such an automobile fitted with a permanently closed shatterproof window on the driver's door that complies with strength requirements imposed above will be deemed to comply with the requirement for a window net.
 - (iii) On each other automobile the net must be mounted to the safety cage.
- Note:** Each 5th Category automobile, when competing in an event exclusively for such an automobile, is exempt from the requirement for Window Nets.
- (c) Each Off Road automobile, must be equipped (for each occupant) with a safety net or arm restraints in accordance with the following.
- (i) Each device must ensure that each arm of each crew member cannot project beyond the line of the bodywork of the automobile.
 - (ii) Where an occupant is not using arm restraints a window net must be used to cover each opening, except for the front window opening.
 - (iii) For an automobile with an opening roof each occupant shall be required to have a wrist/arm restraint on each arm.
 - (iv) If arm restraints are used they must be worn by each occupant at all times whilst the automobile is moving in competition. A wrist restraint must be at least to an SFI 3.3 standard.

Table I-1

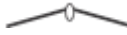
	Configuration	Acceptable Standards	Identification
A	6-Point Harness 	FIA 8853-2016 ³ FIA 8853/98 ¹ SFI 16.1 ²	  
	5-Point Harness 		
B	4-Point Harness 	Includes Level A FIA 8854/98 ¹ AS 2596 ECE R16	  
	3-Point Harness 		
C	Lap Sash Belt 	AS 2596 ECE R16 AS E35	
D	Lap Belt 	AS 2596 ECE R16 AS E35	

NOTE:

¹ "Not valid after XXXX" shown on each strap as detailed below:

- (i) For International events, safety harnesses must not be used after 31 December of the year stated (XXXX).

- (ii) For all other events, safety harnesses must not be used after 31 December, five years after the year stated (XXXX).

The extension of the safety harness validity detailed above for non – international events is subject to the following conditions:

- (iii) Safety harnesses must be inspected during the normal scrutiny process;
- (iv) Each competitor must inspect and replace any damaged or worn safety harness before any competition as required.

² SFI Harness to be returned to original manufacturer for re-webbing within two years of the date of manufacture shown on SFI label or be replaced. This requirement is imposed by the SFI Foundation (Inc).

³ [FIA 8853-2016 only in accordance with FIA Presentation Forms: https://www.fia.com/presentation-forms-harnesses-according-fia-standard-8853-2016](https://www.fia.com/presentation-forms-harnesses-according-fia-standard-8853-2016)

Table I-2

Event Type	Event Permit Level	Type	Notes
Observed Section Trial or Motorkhana	All	D	
Khanacross	All	C	“Specials” only: Type B minimum
Speed Events*	Club, Multi-club	C	
	State and above	C	Registered closed automobiles
		B ²	All other automobiles
Races ¹ - 1st Category Group 2A/2C	All non-International	A	
	International	A	FIA only
Races* - Other automobiles	Club, Multi-club	A	
	State	A	
	National	A	
	International	A	FIA only
Rallies	Introductory	C	Where a safety cage structure is not required
	Club	B³	
	Multi-club	A	
	State	A	
	National	A	
	Tarmac	A	
	International	A	FIA only
Rallysprint	S1	C	
	S2	B	
Other Road Events	Touring Assemblies	C, D	Must comply with civil regulations
	Touring Road	C, D	Where a safety cage structure is not required
		B	During activities requiring a safety cage structure
Off Road	All non-International	A	
	International	A	FIA only

NOTE:

¹ Except 5th Category: For automobiles of the 5th Category whilst competing in events exclusively for the 5th Category, each safety harness shall be of a type and configuration as specified in the specific group technical regulations.

² [Level A required for use with FHR as of 1 January 2020.](#)

³ A Type A Safety Harness will be mandatory for Club level effective 1 January 2020.

Drawing I-1

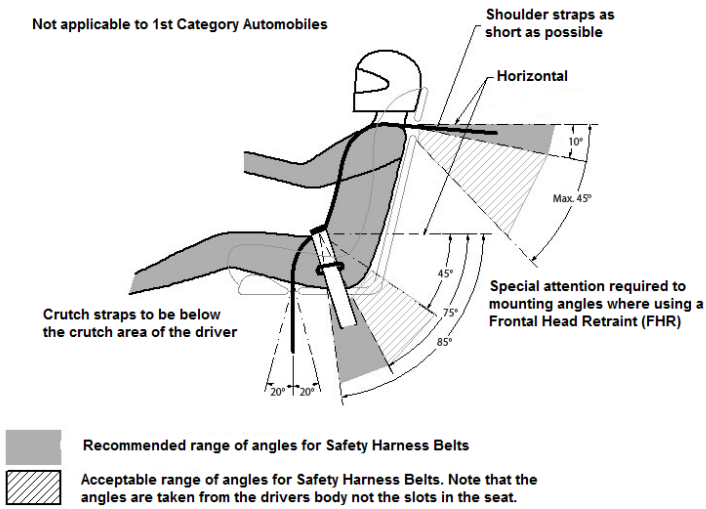

Drawing I-2

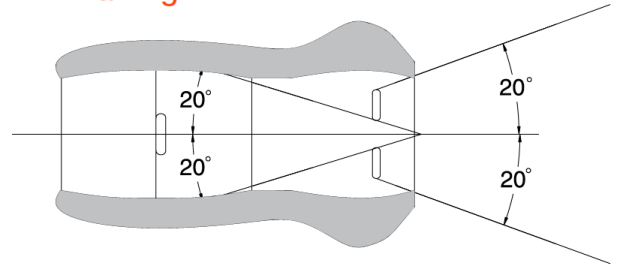

Drawing I-3

1st Category and similar automobiles

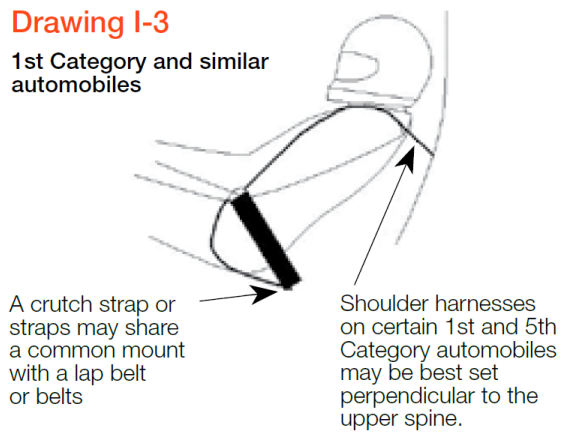

Drawing I-4

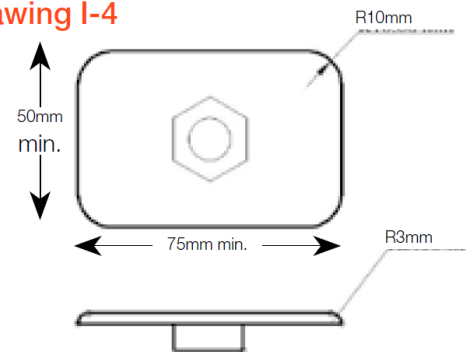

Drawing I-5



Drawing I-6

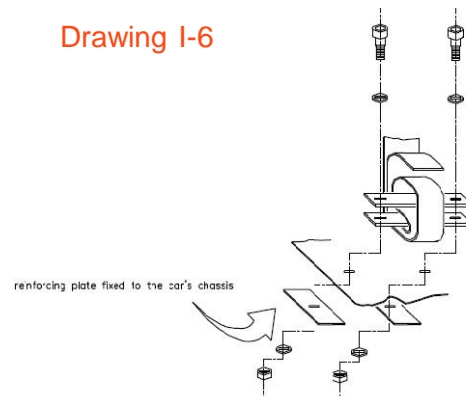

Drawing I-7

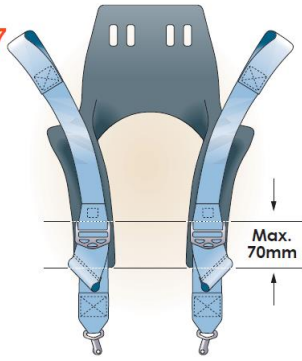

Drawing I-8

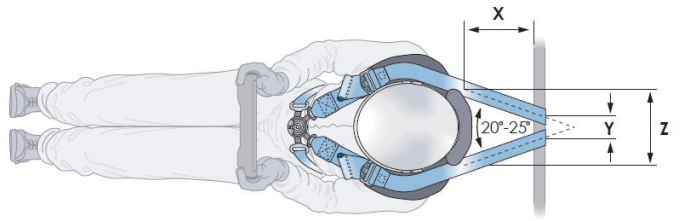

Drawing I-9

Recommended harness placement with use with FHR

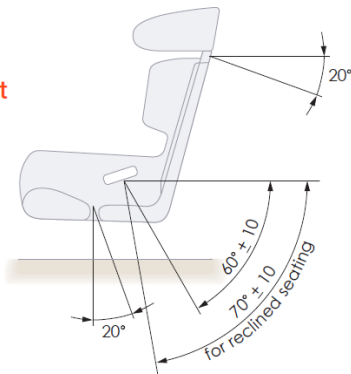

Drawing I-10

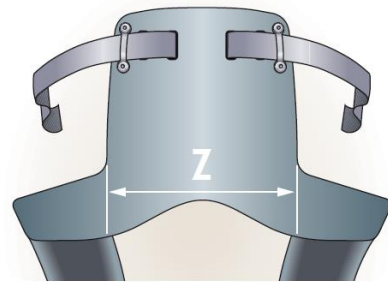

Table I – 3

Table 1: Reference Values for 120mm FHR Collar

Z FHR COLLAR WIDTH (MM)	120							
X FHR to belt anchorage (mm)	100	200	300	400	500	600	700	800
Y belt anchorage to separation (mm)	135- (110)	95 (70)	55 (30)	15 (-10)	-25 (-50)	-65 (-90)	-105 (-130)	-145 (-170)

Table 2: Reference Values for 140mm FHR Collar

Z FHR COLLAR WIDTH (MM)	140							
X FHR to belt anchorage (mm)	100	200	300	400	500	600	700	800
Y belt anchorage to separation (mm)	155 (130)	115 (90)	75 (50)	35 (10)	-5 (-30)	-45 (-70)	-85 (-110)	-125 (-150)

Table 3: Reference Values for 160mm FHR Collar

Z FHR COLLAR WIDTH (MM)	160							
X FHR to belt anchorage (mm)	100	200	300	400	500	600	700	800
Y belt anchorage to separation (mm)	175 (150)	135 (110)	95 (70)	55 (30)	15 (-10)	-25 (-50)	-65 (-90)	-105 (-130)

Table 4: Reference Values for 180mm FHR Collar

Z FHR COLLAR WIDTH (MM)	180							
X FHR to belt anchorage (mm)	100	200	300	400	500	600	700	800
Y belt anchorage to separation (mm)	195 (170)	155 (130)	115 (90)	75 (50)	35 (10)	-5 (-30)	-45 (-70)	-85 (-110)

Definitions for the reference values:

- dimension Z (mm) = width of the FHR collar, as shown in Drawing I-8 and I-10
- dimension X (mm) = distance from the rear edge of the FHR-belt-bearing-surface to the automobile attachment point (mm) as shown in Drawing I-8
- dimension Y (mm) = separation of the centres of the two shoulder straps at the automobile attachment points (mm) as shown in Drawing I-8